

A P P N O T E S SM

IPC-7351B Electronic Component Zero Orientation For CAD Library Construction

Copyright © 2010 Mentor Graphics Corporation

Trademarks that appear in Mentor Graphics product publications that are not owned by Mentor Graphics are trademarks of their respective owners.

CONTENTS

1	INTRODUCTION	1
1.1	Scope	1
1.2	Purpose	1
2	CHIP COMPONENTS	3
2.1	Chip Capacitor	3
2.2	Chip Resistor	3
2.3	Chip Inductor	3
3	MOLDED COMPONENTS	4
3.1	Molded Capacitors	4
3.2	Molded Diodes	4
3.3	Molded Inductors	4
4	PRECISION WIRE-WOUND	5
4.1	Precision Wire Wound Components	5
5	MELF COMPONENTS	6
5.1	MELF Diodes	6
5.2	MELF Resistors	6
6	ALUMINUM ELECTROLYTIC CAPACITORS	8
6.1	Aluminum Electrolytic Capacitors	8
7	SOT COMPONENTS	9
7.1	SOT23-3	9
7.2	SOT23-5	9
7.3	SOT343	9
7.4	SOT223	9
8	TO COMPONENTS	10
8.1	TO252 (DPAK)	10
9	SMALL OUTLINE GULLWING COMPONENT	11
9.1	SOIC, SOP & SSOP	11
9.2	TSSOP	11
10	SMALL OUTLINE J-LEAD COMPONENTS	12
10.1	SOIC J-Lead	12
11	QUAD FLAT PACKAGE	13
11.1	Square QFP Pin 1 on Side	13
11.2	Rectangle QFP Pin 1 on Side	13
12	BUMPER QUAD FLAT PACKAGE	14
12.1	Bump QFP Pin 1 on Side	14
12.2	Bump QFP Pin 1 in Center	14
13	CERAMIC FLAT PACKAGE	15
13.1	Ceramic Flat Package	15
14	CERAMIC QUAD FLAT PACKAGE	16
14.1	CQFP (Ceramic Quad Flat Package)	16
15	PLASTIC LEADED CHIP CARRIERS	17

15.1	PLCC Square	17
15.2	PLCC Rectangular	17
16	LEADLESS CHIP CARRIERS	18
16.1	LCC Square	18
17	QUAD FLAT NO-LEAD	19
17.1	QFN Square	19
17.2	QFN Rectangular Vertical	19
17.3	QFN Rectangular Horizontal	19
18	BALL GRID ARRAY.....	20
18.1	BGA Square	20
18.2	BGA Rectangular	20
19	COMPONENT ZERO ORIENTATIONS.....	21
19.1	Summary	21

1 INTRODUCTION

1.1 Scope

To establish a consistent technique for the description of electronic component orientation, and their land pattern geometries, that facilitates and encourages a common data capture and transfer methodology amongst and between global trading partners.

1.2 Purpose

IPC, in conjunction with the International Electrotechnical Commission (IEC), have established several standards that are in the process of being coordinated. One of the standards is on the design of land patterns geometries (IPC-7351/IEC 61188-5-1); the other set is on electronic description for data transfer between design and manufacturing (IPC-2581/IEC 61182-2). In order to maintain a consistent method where these two important standards describe the component mechanical outlines, and their respective mounting platforms, a single concept must be developed that takes into account various factors within the global community.

One of these factors is that of establishing a CAD component description and land pattern standard that adopts a fixed Zero Component Orientation so that all CAD images are built with the same rotation for the purpose of assembly machine automation.

The land pattern standards clearly define all the properties necessary for standardization and acceptability of a “One World CAD Library”. The main objective in defining a one world CAD library is to achieve the highest level of “Electronic Product Development Automation”. This encompasses all the processes involved from engineering to PCB layout to fabrication, assembly and test. The data format standards need this type of consistency in order to meet the efficiency that electronic data transfer can bring to the industry.

Many large firms have spent millions of dollars creating and implementing their own unique standards for their own “Electronic Product Development Automation”. These standards are proprietary to each firm and are not openly shared with the rest of the industry. This has resulted in massive duplication of effort costing the industry millions of man hours in waste and creating industry chaos and global non-standardization.

The industry associations responsible for component descriptions and tape and reel orientation have tried valiantly to influence the industry by making good standards that describe the component outlines and how they should be positioned in the delivery system to the equipment on the manufacturing floor.

Suppliers of parts have either not adhered to the recommendations or have misunderstood the intent and provided their products in different orientations.

The Land pattern standards (both IPC-7351 and IEC 61188-5-1) put an end to the “Proprietary Intellectual Property” and introduce a world standard so every electronics firm can benefit from Electronic Product Development Automation. The data format standards (IPC-2581 and IEC 61182-2) are an open database XML software code that is neutral to all the various CAD ASCII formats. For true machine automation to exist, the world desperately needs a neutral CAD database format that all PCB manufacturing machines can read.

The main purpose of creating the land pattern standards is to achieve reliable solder joint formation platforms; the reason for developing the data transfer structure is to improve the efficiency with which engineering intelligence is converted to manufacturing reality. Even if the neutral CAD format can drive all the manufacturing machines, it would be meaningless unless the component description standard for CAD land patterns was implemented with some consistency. Zero Component Orientation has a key role in machine automation.

The obvious choice for global standardization for EE hardware engineering, PCB design layout, manufacturing, assembly and testing processes is to incorporate the standard land pattern conventions. Any other option continues the confusion and additional manual hours of intervention in order to achieve the goals of automation. In addition, the ease of having one system export a file so that another system can accomplish the work may require unnecessary manipulation of the neutral format in order to meet the object of clear, unambiguous software code.

The design of any assembly will continue to permit arrangement and orientation of components at any orientation consistent with design standards. Starting from a commonly understood data capture concept will benefit the entire supply chain.

2 CHIP COMPONENTS

2.1 Chip Capacitor

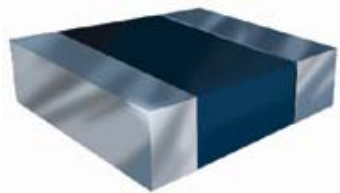

Component

Pin 1 on Left Side

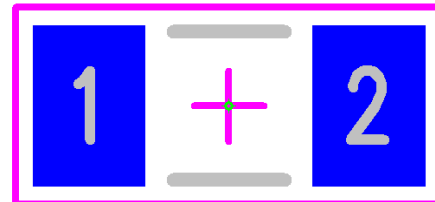

Land Pattern

2.2 Chip Resistor

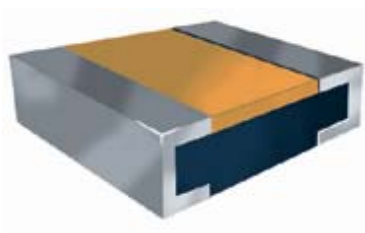

Component

Pin 1 on Left Side

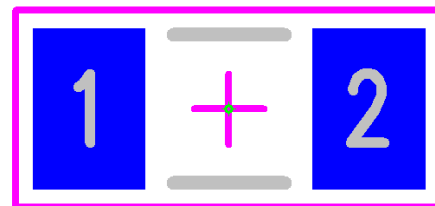

Land Pattern

2.3 Chip Inductor

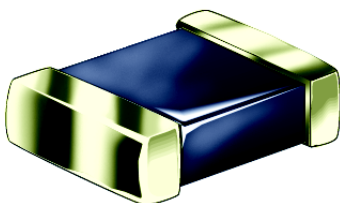

Component

Pin 1 on Left Side

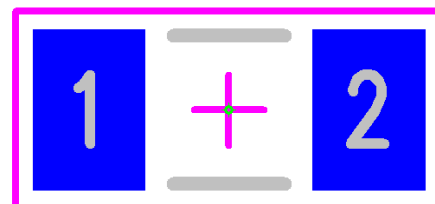

Land Pattern

Note: Pin 1 is always the “Positive” pin

3 MOLDED COMPONENTS

3.1 Molded Capacitors



Component

Pin 1 on Left Side

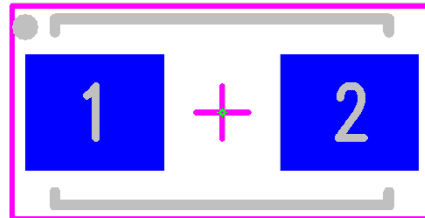

Land Pattern

3.2 Molded Diodes

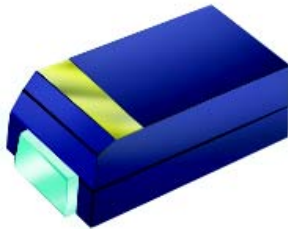

Component

Pin 1 on Left Side (Cathode)

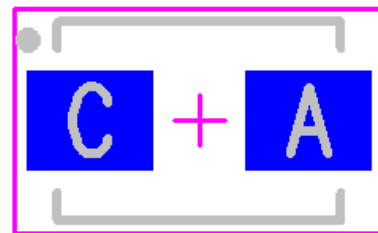

Land Pattern

3.3 Molded Inductors



Component

Pin 1 on Left Side

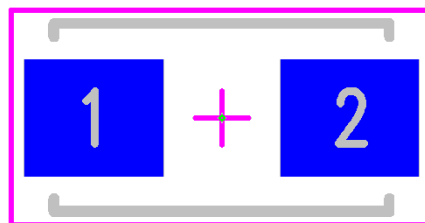

Land Pattern

Note: Pin 1 is always the “Positive” pin

4 PRECISION WIRE-WOUND

4.1 Precision Wire Wound Components



Component

Pin 1 on Left Side

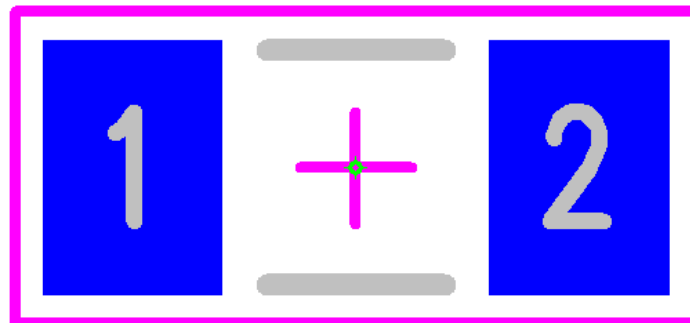

Land Pattern

Note: Pin 1 is always the “Positive” pin

5 MELF COMPONENTS

5.1 MELF Diodes

Pin 1 on Left Side (Cathode)

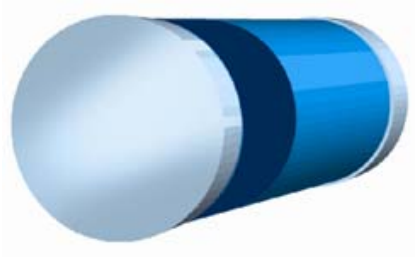

Component

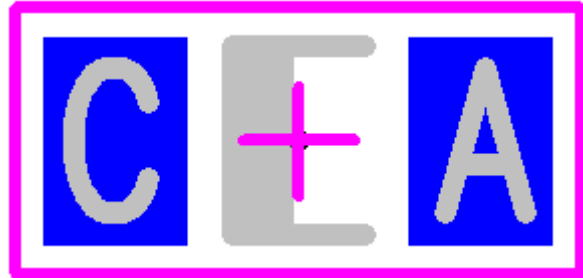

Land Pattern

5.2 MELF Resistors

Pin 1 on Left Side

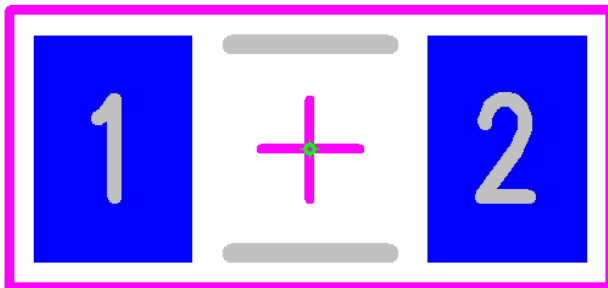
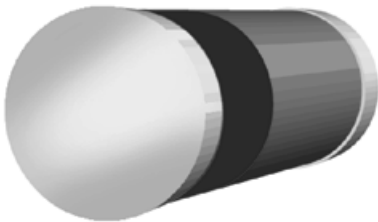

Component

Land Pattern

Note: Pin 1 is always the “Polarity Mark” pin or Cathode

6 ALUMINUM ELECTROLYTIC CAPACITORS

6.1 Aluminum Electrolytic Capacitors

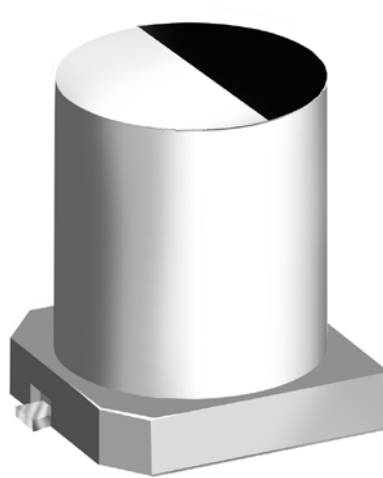

Component

Pin 1 on Left Side

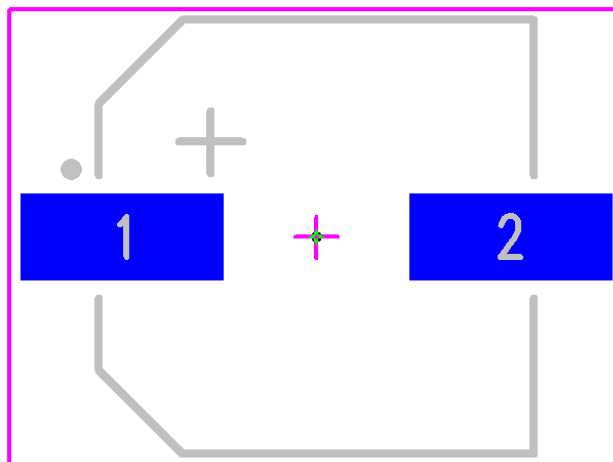

Land Pattern

Note: Pin 1 is always the “Positive” pin

7 SOT COMPONENTS

7.1 SOT23-3



Component

Pin 1 on Upper Left

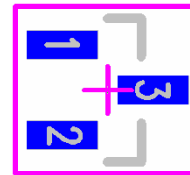

Land Pattern

7.2 SOT23-5



Component

Pin 1 on Upper Left

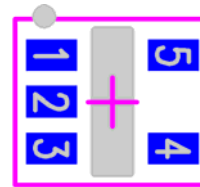

Land Pattern

7.3 SOT343

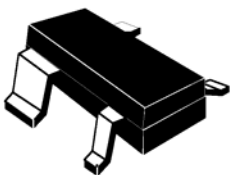

Component

Pin 1 on Upper Left

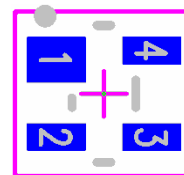

Land Pattern

7.4 SOT223



Component

Pin 1 on Upper Left

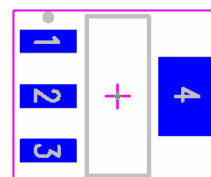

Land Pattern

8 TO COMPONENTS

8.1 TO252 (DPAK)

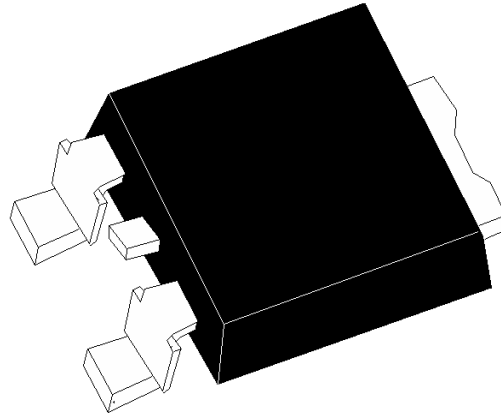

Component

Pin 1 on Upper Left

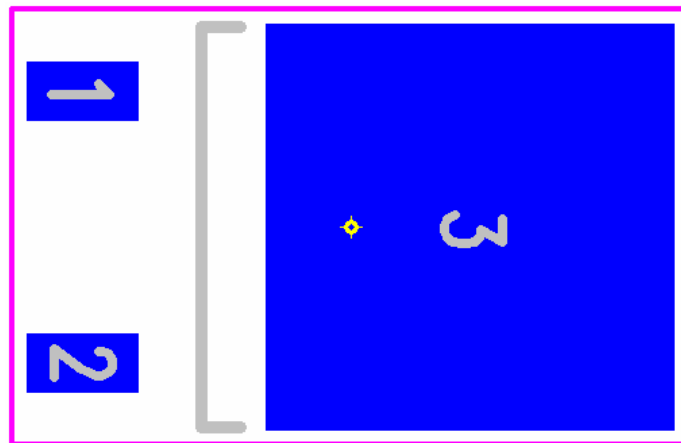

Land Pattern

9 SMALL OUTLINE GULLWING COMPONENT

9.1 SOIC, SOP & SSOP

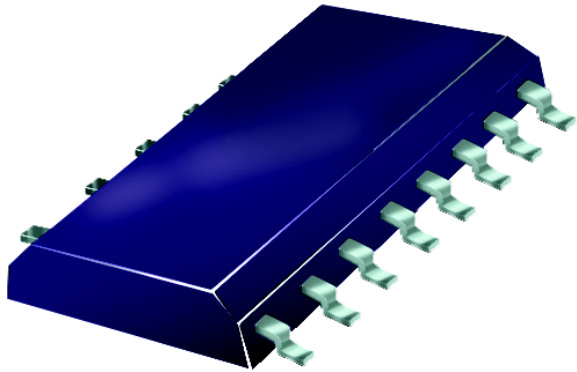

Component

Pin 1 on Upper Left

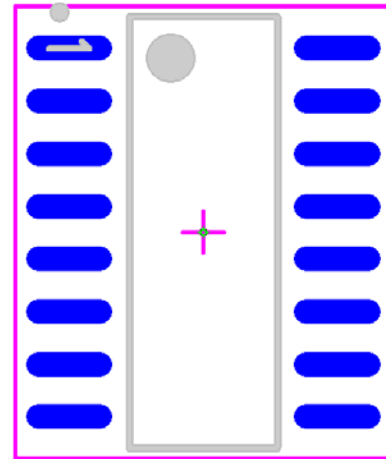

Land Pattern

9.2 TSSOP

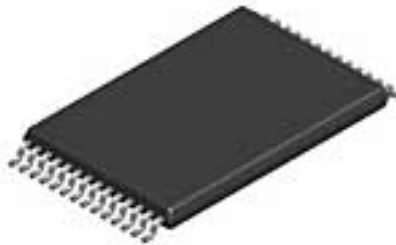

Component

Pin 1 on Upper Left

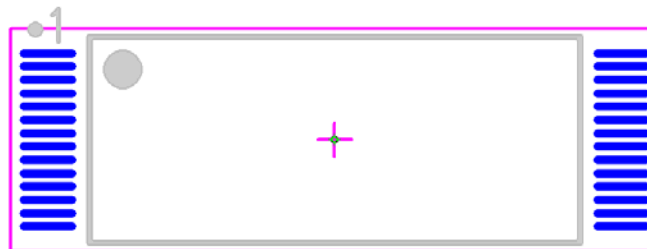

Land Pattern

10 SMALL OUTLINE J-LEAD COMPONENTS

10.1 SOIC J-Lead

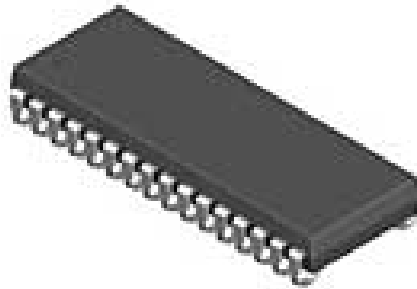

Component

Pin 1 on Upper Left

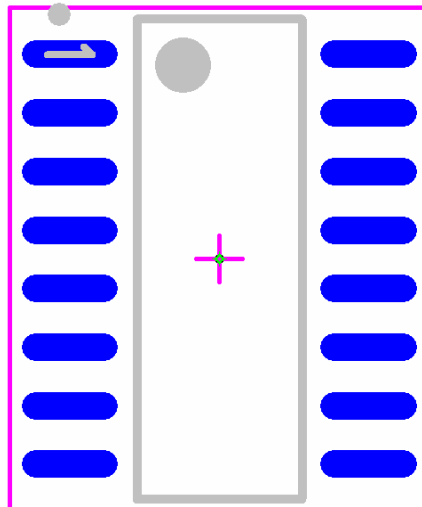

Land Pattern

11 QUAD FLAT PACKAGE

11.1 Square QFP Pin 1 on Side

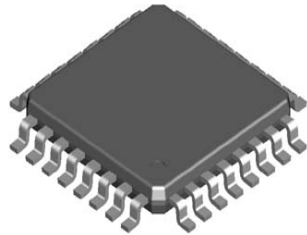

Component

Pin 1 on Upper Left

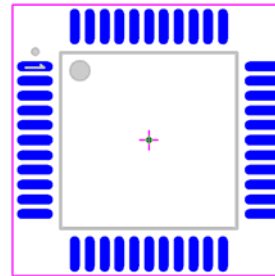

Land Pattern

11.2 Rectangle QFP Pin 1 on Side



Component

Pin 1 on Upper Left

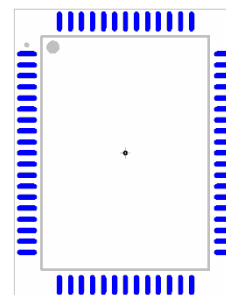

Land Pattern

12 BUMPER QUAD FLAT PACKAGE

12.1 Bump QFP Pin 1 on Side

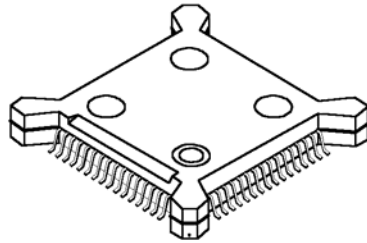

Component

Pin 1 on Upper Left

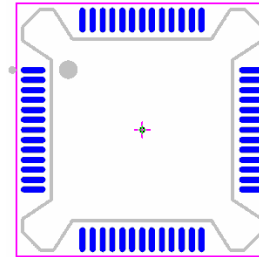

Land Pattern

12.2 Bump QFP Pin 1 in Center

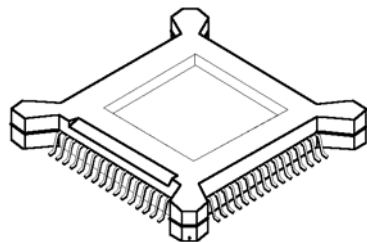

Component

Pin 1 on Top Center

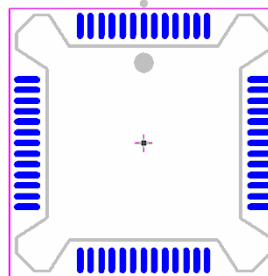

Land Pattern

13 CERAMIC FLAT PACKAGE

13.1 Ceramic Flat Package

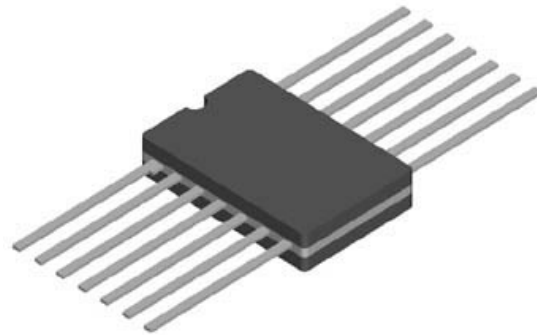

Component

Pin 1 on Upper Left

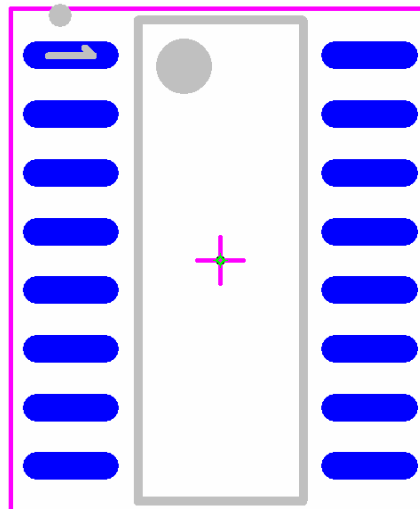

Land Pattern

14 CERAMIC QUAD FLAT PACKAGE

14.1 CQFP (Ceramic Quad Flat Package)

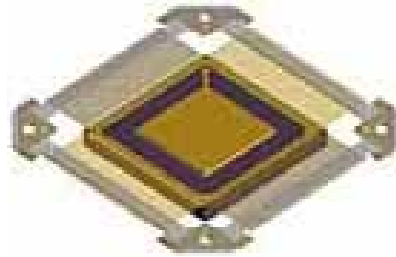

Component

Pin 1 on Upper Left

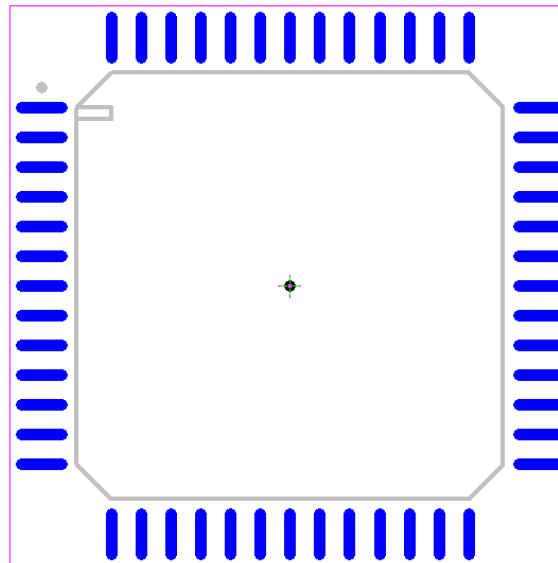

Land Pattern

15 PLASTIC LEADED CHIP CARRIERS

15.1 PLCC Square

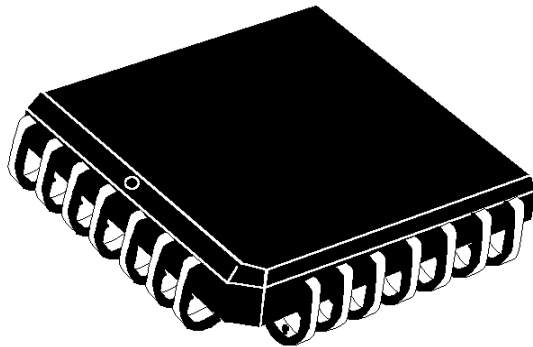

Component

Pin 1 on Top Center

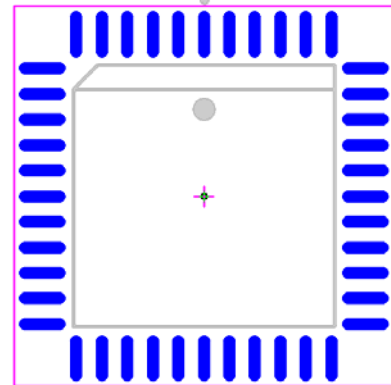

Land Pattern

15.2 PLCC Rectangular

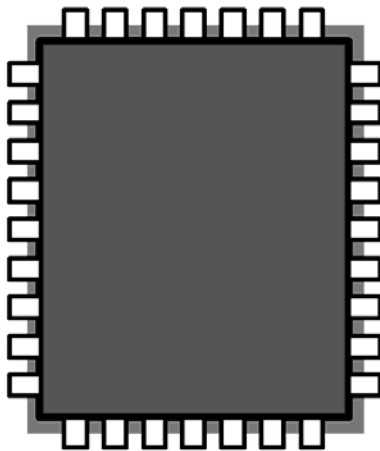

Component

Pin 1 on Top Center

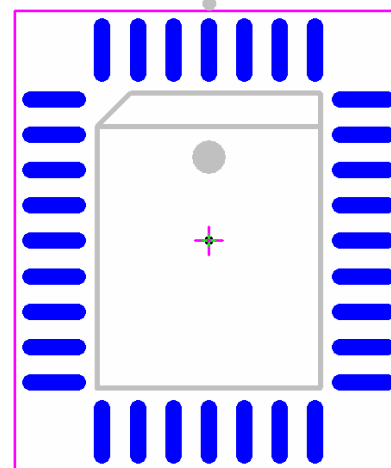

Land Pattern

16 LEADLESS CHIP CARRIERS

16.1 LCC Square

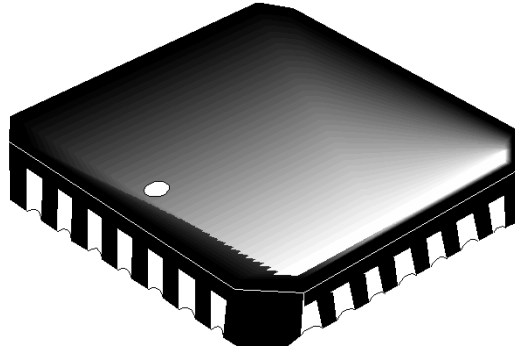

Component

Pin 1 on Top Center

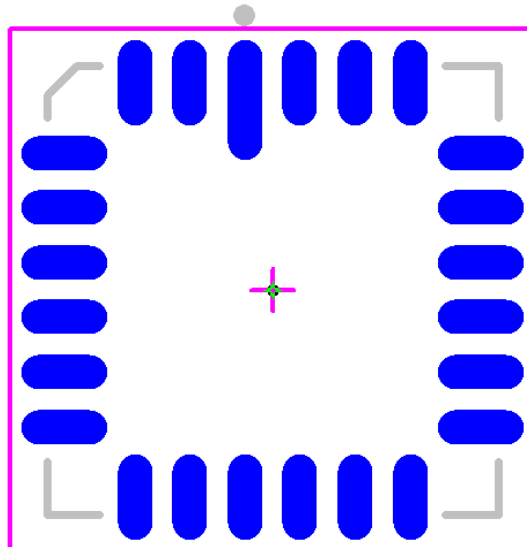

Land Pattern

17 QUAD FLAT NO-LEAD

17.1 QFN Square

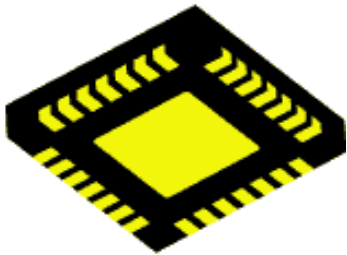

Component (Bottom View)

Pin 1 on Upper Left

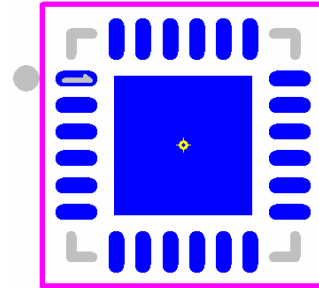

Land Pattern

17.2 QFN Rectangular Vertical

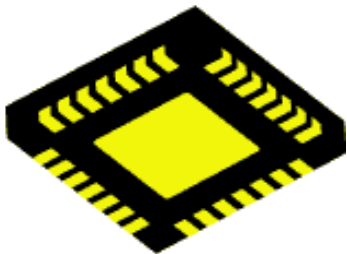

Component (Bottom View)

Pin 1 on Upper Left

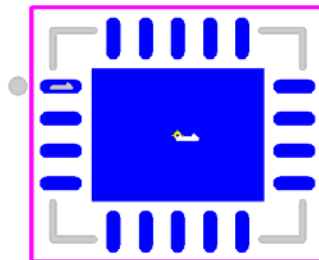

Land Pattern

17.3 QFN Rectangular Horizontal

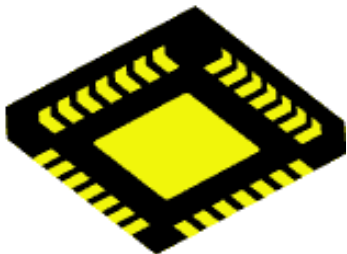

Component (Bottom View)

Pin 1 on Upper Left

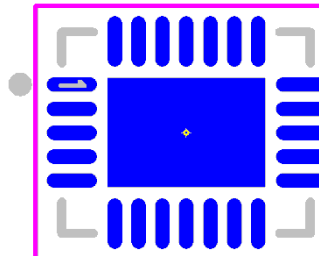

Land Pattern

18 BALL GRID ARRAY

18.1 BGA Square

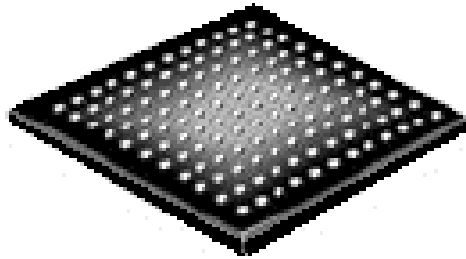

Component (Bottom View)

Pin A1 in Upper Left

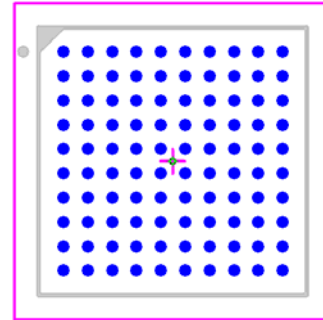

Land Pattern

18.2 BGA Rectangular

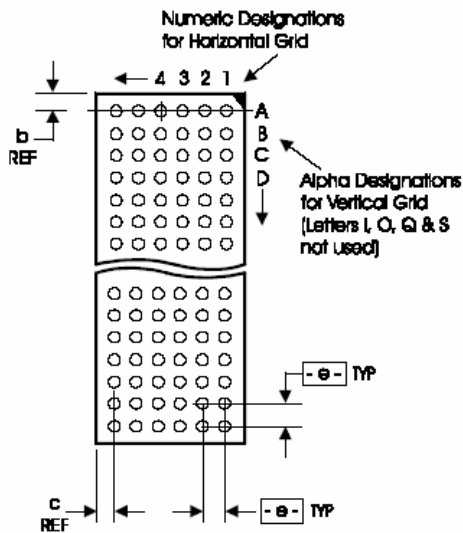

Component (Bottom View)

Pin A1 in Upper Left

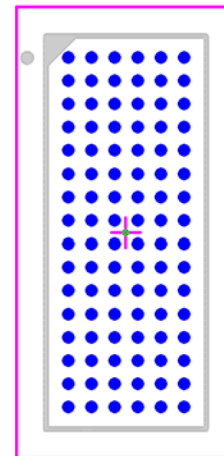

Land Pattern

19 COMPONENT ZERO ORIENTATIONS

19.1 Summary

Surface Mount Land Patterns

IPC-735* Component Family Breakdown:

- IPC-7351** = IEC 61188-5-1, Generic requirements - land/joint considerations – **General Description**
- IPC-7352** = IEC 61188-5-2, Sectional requirements - land/joint considerations – **Discrete Components**
- IPC-7353** = IEC 61188-5-3, Sectional requirements - land/joint considerations – **Gull-wing leads, two sides (SOP)**
- IPC-7354** = IEC 61188-5-4, Sectional requirements - land/joint considerations – **J leads, two sides (SOJ)**
- IPC-7355** = IEC 61188-5-5, Sectional requirements - land/joint considerations – **Gull-wing leads, four sides (QFP)**
- IPC-7356** = IEC 61188-5-6, Sectional requirements - land/joint considerations – **J leads, four sides (PLCC)**
- IPC-7357** = IEC 61188-5-7, Sectional requirements - land/joint considerations – **Post leads, two sides (DIP)**
- IPC-7358** = IEC 61188-5-8, Sectional requirements - land/joint considerations – **Area Array Components (BGA)**
- IPC-7359** = NO IEC Document, Sectional requirements - land/joint considerations – **No Lead Components (LCC)**

Component Zero Orientations Pin 1 Location For CAD Library Construction

- 1) Chip Capacitors, Resistors and Inductors (RES, CAP and IND) – **Pin 1 (Positive Pin) on Left**
- 2) Molded Inductors (INDM), Resistors (RESM) and Tantalum Capacitors (CAPT) – **Pin 1 (Positive Pin) on Left**
- 3) Precision Wire-wound Inductors (INDP) – **Pin 1 (Positive Pin) on Left**
- 4) MELF Diodes – **Pin 1 (Cathode) on Left**
- 5) Aluminum Electrolytic Capacitors (CAPAE) – **Pin 1 (Positive) on Left**
- 6) SOT Devices (SOT23, SOT23-5, SOT223, SOT89, SOT143, etc.) – **Pin 1 Upper Left**
- 7) TO252 & TO263 (DPAK Type) Devices – **Pin 1 Upper Left**
- 8) Small Outline Gullwing ICs (SOIC, SOP, TSOP, SSOP, TSSOP) – **Pin 1 Upper Left**
- 9) Ceramic Flat Packs (CFP) – **Pin 1 Upper Left**
- 10) Small Outline J Lead ICs (SOJ) – **Pin 1 Upper Left**
- 11) Quad Flat Pack ICs (PQFP, SQFP) – **Pin 1 Upper Left**
- 12) Ceramic Quad Flat Packs (CQFP) – **Pin 1 Upper Left**
- 13) Bumper Quad Flat Pack ICs (BQFP Pin 1 Center) – **Pin 1 Top Center**
- 14) Plastic Leaded Chip Carriers (PLCC) – **Pin 1 Top Center**
- 15) Leadless Chip Carriers (LCC) – **Pin 1 Top Center**
- 16) Leadless Chip Carriers (LCCS Pin 1 on Side) – **Pin 1 Upper Left**
- 17) Quad Flat No-Lead ICs (QFN) QFNS, QFNRV, QFNRH – **Pin 1 Upper Left**
- 18) Ball Grid Arrays (BGA) – **Pin A1 Upper Left**